



ASSA ABLOY offers a complete range of quality cylinders. There are a number of cylinder types available, each offering a range of functional and security-oriented features.

Features:

- Can be keyed alike to other ASSA ABLOY CYL4™ cylinders for one key convenience
- Construction key and master key systems are available upon request
- The Oval, Euro, Rim, and Key N Knob series are C4 compatible and available in 5 or 6-pin options
- **Euro Cylinder Note:** P3000E Emergency type double cylinder assemblies are MC35 Securiturn™ compatible

Key Compatible Cylinder Types:

- C4 Pin Cylinder
 - P3000 Euro Cylinder Series
 - MC570 Oval Cylinder Series
 - MC17 Rim Cylinder Series
 - MC2600 Key N Knob Cylinder Series
 - 180250 Albany Sliding Door Cylinder
- C4 Wafer Cylinder
 - CYL4 Wafer Cylinder

E Type Cylinder

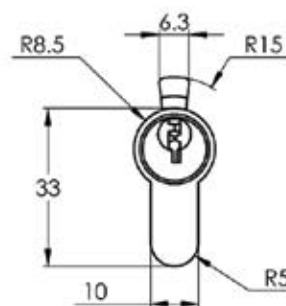
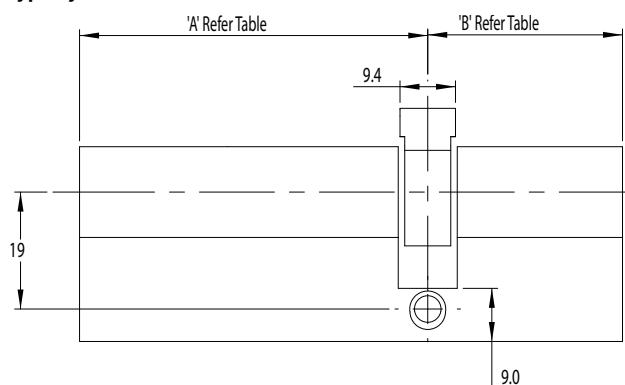

EURO 'E' TYPE DOUBLE CYLINDER

PART NUMBER	FINISH	NO. OF PINS	A	B	COMMENTS/DESCRIPTIONS
P33016E	S/CHROME	5	62	32	5 PIN C4 WITH 5 PIN TRAP CUT MC35
P33022E	S/CHROME	5	31	31	5 PIN C4 WITH 5 PIN TRAP CUT MC35
P33040E	S/CHROME	5	40	40	5 PIN C4 WITH 5 PIN TRAP CUT MC35
P33235E	S/CHROME	5	38	38	5 PIN C4 WITH 5 PIN TRAP CUT MC35
P33024E	S/CHROME	5/3	31	21	5 PIN C4 WITH 3 PIN V CUT MC35
P33260E	S/CHROME	5	33	48	5 PIN C4 WITH 5 PIN TRAP CUT MC35
P33274E	S/CHROME	5/3	51	21	5 PIN C4 WITH 3 PIN V CUT MC35
P33275E	S/CHROME	3	21	21	5 PIN C4 WITH 3 PIN V CUT MC35
P33276E	S/CHROME	5	34	34	5 PIN C4 WITH 3 PIN V CUT MC35
P33280E	S/CHROME	3	24	24	5 PIN C4 WITH 3 PIN V CUT MC35

RES-FEY-055-0410NZ

Half Cylinder

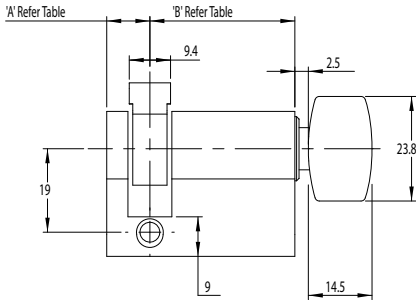

Full Cylinder

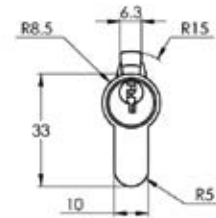
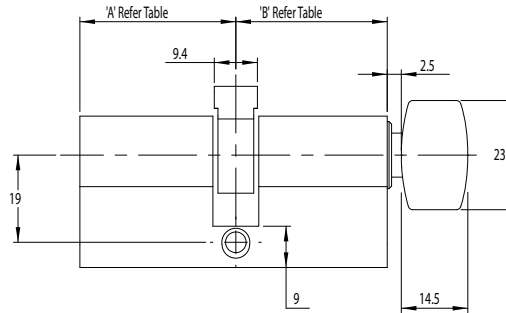

EURO CYLINDERS – FIXED CAM

PART NUMBER	FINISH	NO. OF PINS	A	B	COMMENTS / DESCRIPTION
P33021	S/CHROME	5	45	45	EXTENDED DOUBLE KEYED TO J001
P33230	POL BRASS	5	10	47.5	HALF CYLINDER TURN KNOB
P33231	S/CHROME	5	10	47.5	HALF CYLINDER TURN KNOB
P33032	POL BRASS	5	31	31	KEY & TURN KNOB
P33033	POL BRASS	5	31	31	DOUBLE KEYED
P33034	S/CHROME	5	31	31	KEY & TURN KNOB
P33035	S/CHROME	5	31	31	DOUBLE KEY
P33045	S/CHROME	5	10	31	HALF CYLINDER KEYED
P33046	S/CHROME	6	35	35	DOUBLE KEYED WITH GRUB SCREW TOP PIN CLOSURE
P33047	S/CHROME	6	35	35	KEY & TURN KNOB WITH GRUB SCREW TOP PIN CLOSURE
P33048	POL BRASS	5	10	31	HALF CYLINDER KEYED
P33260	S/CHROME	5	32.5	47.5	OFFSET CYLINDER DOUBLE KEY
P33261	S/CHROME	5	32.5	47.5	OFFSET CYLINDER KEY & TURN KNOB
P33262	POL BRASS	5	32.5	47.5	OFFSET CYLINDER DOUBLE KEY
P33263	POL BRASS	5	32.5	47.5	OFFSET CYLINDER KEY & TURN KNOB
P33264	S/CHROME	5	10	47.5	HALF CYLINDER KEYED
P33265	POL BRASS	5	10	47.5	HALF CYLINDER KEYED
P33277	S/CHROME	5	34	34	5 PIN C4
P33278	S/CHROME	5	10	34	HALF CYLINDER TURN KNOB
P33279	S/CHROME	5	10	34	HALF CYLINDER 5 PIN C4
P33066	S/CHROME	4	10	25.5	HALF CYLINDER KEYED TO J81-J90
P33067	POL BRASS	4	10	25.5	HALF CYLINDER KEYED
P33071	POL BRASS	6	35	35	KEY & TURN KNOB
P33072	POL BRASS	6	35	35	DOUBLE KEYED
P33092	S/CHROME	5	10	31	HALF CYLINDER TURN KNOB
P33093	POL BRASS	5	10	31	HALF CYLINDER TURN KNOB
P33245	S/CHROME	5	10	37.5	HALF CYLINDER KEYED
P33292	S/CHROME	5	10	37.5	HALF CYLINDER TURN KNOB
P33235	S/CHROME	5	37.5	37.5	EXTENDED DOUBLE KEYED
P33234	S/CHROME	5	37.5	37.5	EXTENDED KEY & TURN KNOB
P33233	POL BRASS	5	37.5	37.5	EXTENDED DOUBLE KEYED
P33232	POL BRASS	5	37.5	37.5	EXTENDED KEY & TURN KNOB
P33231	S/CHROME	5	32.5	47.5	OFFSET TURN KNOB
P33230	POL BRASS	5	32.5	47.5	OFFSET TURN KNOB
P33017	S/CHROME	5	62	32	OFFSET CYLINDER TURN KNOB
P33041	S/CHROME	5	40	40	EXTENDED CYLINDER KEY & TURN KNOB
P33042	S/CHROME	5	10	40	HALF CYLINDER KEYED
P33043	S/CHROME	5	10	40	HALF CYLINDER TURN KNOB

EURO CYLINDERS – FLOATING/LAZY CAM

PART NUMBER	FINISH	NO. OF PINS	A	B	COMMENTS / DESCRIPTION
P33119	S/CHROME	5	37.5	37.5	EXTENDED DOUBLE KEYED WITH 143° LOST MOTION CAM
P33097	S/CHROME	5	31	31	DOUBLE KEYED WITH 143° LOST MOTION CAM

Key Compatible Cylinders

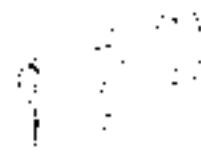

P3000 Series

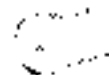

CYL 4



MC570 Series



MC17 Series



MC2600 Series



180250